



Slinger® Bag & Oscillator
USER MANUAL

Slinger®

Designed and Developed by Slinger®.
Patent Pending.

Covered by International Patent Applications

2709 N. Rolling Road Suite 138 Windsor Mill 21244 MD USA

I am Joe. Founder of Slinger®.

Like you I love to workout playing Tennis each day. However, I constantly found myself challenged to find a playing partner.

So I decided to try the club ball machine. Ugh! Having taken me 30 minutes to drag it to the court and locate cables and power, even more time was wasted figuring out how it actually worked! Frustrated I gave up. This experience led to my idea to create a ball machine built into a regular sized roller trolley bag. Eureka! Slinger® was born! A lightweight, transportable, versatile and affordable Tennis Ball Launcher. All my tennis gear in one place together with a Ball Launcher that can be set up anywhere within a few minutes. My 24-7 Tennis Partner!

Thank you for being on this journey with me.



Joe Kalfa
Founder

I am Mike. CEO of Slinger®.

I have been involved in tennis all my life, playing, coaching and running tennis businesses. I know the challenge our sport has in both retaining current players and attracting new players. Of tennis players who left Tennis in the past 12 months, 34% did so due to the lack of a partner to play with.

Slinger® helps to solve this problem. Re-Inventing Tennis, making it accessible to all.

Following thousands of hours of design, prototyping and both on and off court testing, we have taken Joe's idea and transformed Slinger® into a performance piece of tennis equipment. Slinger® a tennis innovation for players of all ages and abilities.

Thank you for supporting Slinger®. Designed by Players for Players.

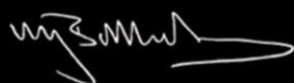

Mike Ballardie
CEO

Quick Access Links

CLICK ON THE ICONS BELOW FOR DIRECT ACCESS TO YOUR AREA OF INTEREST



QUICK START

4



SAFETY

7



FEATURES

8



GETTING STARTED

11



BATTERY

12



LED INDICATORS

16



LAUNCHER CONTROLS

18



ELEVATION KNOB

19



REMOTE CONTROL

21

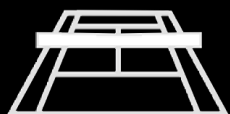

COURT PLACEMENT

22



TROUBLESHOOTING
& MAINTENANCE

24



WARRANTY

27



COMPLIANCE

30

QUICK START SLINGER BAG ONLY (NO OSCILLATOR)

Only after the battery has been initially charged **for up to 5 hours as indicated on Page 12** is the Slinger Bag ready to be used on court.

Please follow these quick start operating guidelines

1. Position Slinger Bag on the court in your desired launching position. See our suggested positions based on level of play [on pages 22 & 23](#).
2. Open / Unzip the lower front panel in order to display the Ball Launcher.



USER NOTE

Hook the open door panel on to the side of the Trolley Bag using the clip provided on the left rear side as you look at the launcher.

3. Open / Unzip the top ball feeder panel. Make sure that nothing is obstructing the ball feeder. If all is clear load up to a recommended maximum of 144 tennis balls.



USER NOTE

Slinger advises that the optimum ball launcher operation is achieved with 72 tennis balls.

4. On the front control panel adjust the control knobs to set the desired BALL SPEED and BALL FEED timing . See our suggested positions based on level of play [on pages 22 & 23](#).

On the right bottom side of the launcher (as you look at it) unzip the elevation control knob cover. Adjust the elevation control knob to your desired launching angle - between 10° and 40°. See our suggested positions based on level of play [on pages 22 & 23](#).



USER NOTE

You will hear a single “beep” to signal that the launcher wheel has started. After 10 seconds you will hear a second “beep” signalling that the feeder plate is rotating and the balls are about to commence launching.

5. Turn ‘ON’ the Launcher power switch on the front control panel.
6. With all of the controls set up, take the remote control and proceed to your playing position.
7. Point the remote control at the Launcher and press the top “On/Off” tennis ball icon button once in order to activate the ball feeder mechanism.
8. START PLAYING!

QUICK START LAUNCHER WITH THE OSCILLATOR

Only after the battery has been initially charged **for up to 5 hours as indicated on Page 12** is the Slinger Bag ready to be used on court.

Please follow these quick start operating guidelines

1. Position Slinger Bag on the court in your desired launching position. See our suggested positions based on level of play [on pages 22 & 23.](#)
2. Make sure that the Slinger® logo on the top of the Oscillator is facing forwards to the net and the wheel location slots are positioned at the rear.
3. Position Slinger Bag onto the top of the Oscillator making sure that the wheels are correctly located into the wheel slots provided on the Oscillator base.
4. Open the lower front panel to display the ball launcher.



USER NOTE

Hook the open door panel on to the side of the Trolley Bag using the clip provided on the left rear side as you look at the launcher.

5. Connect the Oscillator cable via the magnetic connector to the corresponding position on the Launcher control panel. You will hear a “beep” and see a **GREEN LED** indicator come on above the oscillator connector socket to indicate the Oscillator is connected.



USER NOTE

Ensure that the Oscillator is positioned in its central (mid) location. This is the ideal starting position to obtain optimum Oscillation performance.

6. Open the top ball feeder panel. Make sure that nothing is obstructing the ball feeder. If all is clear load up to a maximum of our recommended 144 tennis balls.



USER NOTE

Slinger advises that the optimum ball launcher operation is achieved with 72 tennis balls.

7. On the front control panel adjust the control knobs to set the desired BALL SPEED and BALL FEED timing . See our suggested positions based on level of play [on pages 22 & 23.](#)

QUICK START LAUNCHER WITH THE OSCILLATOR

- On the right bottom side of the launcher (as you look at it) unzip the elevation control knob cover. Adjust the elevation control knob to your desired launching angle - between 10° and 40°. See our suggested positions based on level of play on [pages 22 & 23](#).



USER NOTE

After adjusting the elevation Knob please ensure that it is fully tightened before starting the Launcher.

- Now turn 'on' the Launcher power switch.
- With all of the controls set up, take the remote control and proceed to your playing position.
- Point the remote control at the Launcher and press the top "On/Off" tennis ball icon button once in order to activate the ball feeder mechanism and press the bottom "On/Off" Oscillator icon button in order to activate the Oscillator.



USER NOTE

You will hear a single "beep" to signal that the launcher wheel has started. After 10 seconds you will hear a second "beep" signaling that the feeder plate is rotating and the balls are about to commence launching.

- START PLAYING!

Please ensure that the power is switched to "OFF" and unplugged from any electrical connection before attempting any activity which involves reaching into the launcher mechanism for any reason including for maintenance or cleaning.



IMPORTANT

The Slinger Bag cannot operate without the remote control for safety reasons. Please make sure that you do not misplace the remote control.

AT ALL TIMES THE USER MUST NOT UNDER ANY CIRCUMSTANCES:

- Reach into the ball launching exit chute when the power is “ON”
- Look into the ball launching exit chute when the power is “ON”
- Stand directly in front of the ball launching exit chute at any time when the power is “ON”
- Insert any foreign objects of any kind into the ball hopper while the power is “ON”
- Use the Launcher in wet conditions or when rain is on courts or where water has collected.

PLEASE READ ALL USER INSTRUCTIONS BEFORE USE**WARNING**

To reduce the risk of electrical shock, fire, injury to persons, and other damage when using this product, please follow these basic safety precautions.

1. To protect against the risk of electrical shock, never immerse any part of this launcher in water or any other liquid.
2. Close supervision is necessary when operating this launcher near children.
3. Never walk in front of this launcher when it is operating. Tennis balls leave the launcher at high speeds and could cause serious injury.
4. Always stand to the side, or behind the launcher when attempting to alter the settings of the various controls.
5. If it is necessary to free a jammed tennis ball, make sure that the launcher is turned “OFF”.
6. Always wear protective eye-wear when attempting any repairs or adjustments on this Launcher.
7. Never attempt any repairs or adjustments on this launcher when it is plugged in. Always turn the power switch OFF and make sure the charger is not connected to any wall socket.
8. This launcher is intended for launching tennis balls only. Never attempt to use this launcher with any other type of ball or any foreign object whatsoever.
9. Always make sure that the launcher is turned off on the control panel when not in use and when the battery is being charged. Never place your hands or any other part of your body near moving parts, especially the ball feeder plate and the launching wheel. Please be aware that the launching wheel continues to spin at high speed for several minutes after the launcher is switched off and can cause injury or burns if coming in contact with your hands.

SLINGER BAG FEATURES

The Slinger Bag operates to its optimum level when using standard sized Tennis Balls. Please avoid using either old or soft tennis balls as this will reduce performance of the Launcher.

The Slinger Bag is designed for use by tennis players of all ages and abilities.

The Slinger Bag weighs 15kg or 33 lbs (excluding tennis balls). It is one of the lightest performance ball launchers of its kind on the market. The trolley bag is versatile and functional and can carry all your tennis equipment. The launcher can be set up and ready to use in minutes.

The Slinger Bag ball speeds ranges from the Ball Boy low speed of 10mph/16kmph to an advanced player speed of 45mph / 73kmph ball with tournament level topspin.

The Slinger Bag features include:

- Smart-enabled tennis trolley bag with a variety of functional pockets.
- Variable ball feed rate between 2 and 7 seconds.
- Variable ball speed between 10mph/ 16kmh and 45mph/ 73kmh. Note the higher the speed the greater the topspin effect.
- 144 DUNLOP tennis ball capacity ball hopper.



USER NOTE

Slinger recommends using 72 DUNLOP balls for optimum performance.

- Lithium Ion battery.



USER NOTE

Battery Life depends on usage. If used on low settings including Oscillation then the battery life is up to 3.5 hours and this reduces to 1.5hrs when used at maximum speed, feed and oscillation including cell phone charging.

- A multi-country, multi-voltage smart, fast charger. When the battery is fully charged the power is automatically reduced to an occasional smart "pulse" to protect the life span of the battery.



USER NOTE

It is advised to (a) charge the battery outside of the bag when possible and (b) not to charge the battery for more than 5 hours in any charging period.

- Integrated USB charger for mobile/cell phone charging.
- A remote control to operate both the Launcher and the Oscillator remotely with "On" and "Off" control ONLY.
- An elevation bar offers between 10 and 40 degrees of ball elevation.
- The Slinger Oscillator (Oscillator is sold separately or in a bundle) is designed to house the Slinger Bag sitting on top of it and provides side-to-side oscillation of the Slinger Bag.

SLINGER BAG AT A GLANCE



SLINGER BAG AT A GLANCE



1. EXTENDABLE TROLLEY HANDLE



2. CLIP ON CAMERA HOLDER



3. SIDE POCKET TO STORE REMOTE



4. BALL LAUNCHER PROTECTIVE COVER



5. SLINGER OSCILLATOR *



6. BALL HOPPER



7. LITHIUM ION BATTERY DRAWER



8. LAUNCHER GRABHANDLE



9. SMART POWER CABLE



10. BALL LAUNCHER CONTROL



11. TELESCOPE BALLTUBE *



12. LARGE STORAGE POCKET [BRACKETS, EQUIPMENT, GEAR]



13. BALL FEEDER / STORAGE COMPARTMENT

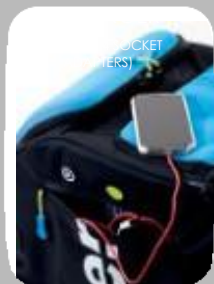

14. POWER PORT (LOCATED IN SIDE POCKET)



15. SIDE POCKET (FOR ADDITIONAL STORAGE)

GETTING STARTED

The Slinger Bag lithium battery is shipped to you at a maximum 30% charge in accordance with federal requirements for shipment of Lithium Batteries.

ASSEMBLING THE CHARGER CABLE

The following are actions will ensure optimum battery life and performance:

- Please select the correct plug socket adaptor for your region.
- Please ensure that the plug socket selected is correctly fitted to the main charger body and that it has “clicked” into place.



NOTE

The battery will not charge if the plug socket is not correctly fitted.

- Connect the power cable to a wall power outlet. Please note a GREEN light will now appear on the charger plug to indicate the power is 'On'.
- Connect the charger cable to the power outlet on the Launcher control panel.



USER NOTE

Please ensure that the power cable is 'pushed' fully into the power socket on the control panel creating a tight connection.

- If the battery has less than full power then the indicator light on the charger plug will show RED and charging will take place. The indicator light will turn GREEN when the battery is fully charged and the power socket should then be removed from the power outlet
- If indicator light remains GREEN then the battery is already fully charged. In this case please immediately disconnect the battery from the power outlet.



NOTE

In order to prevent the battery overheating it is not advised to leave the power outlet connected to the battery for longer than 5 hours in any charging period



NOTE

The Launcher CANNOT be used when connected to the power outlet. This will irreparably damage the battery.

LITHIUM BATTERY

Before using the Launcher for the first time please make sure that the battery is left to charge for a maximum 5 hour charge period in order to optimize the battery life.

The Slinger battery has up to 3.5 hours of battery life at average speed and feed settings.

MAXIMIZING THE LIFE OF THE BATTERY

The following are actions will ensure optimum battery life and performance:

- Charge the battery for a period of 5 hours (maximum) before first use to ensure it is fully charged.
- Recharge battery immediately after each use – again for a charging period of no more than 5 hours.
- Do not store battery in discharged state for any extended period of time. Always ensure there is some minimal charge (30%) held.
- Do not leave the battery connected to the external power supply for any longer than 5 hours in order to prevent the battery overheating.
- Do not store the battery for more than 30 days without recharging it to a minimum 30% level.
- Do not store the Slinger Bag Launcher in a closed car trunk or other location where the internal temperature can reach 100°F or 40° Centigrade. Hot environments speed up battery aging.
- It is best to avoid using your launcher in extremely hot weather or leaving your launcher stored for long periods in rooms that experience direct sunlight for prolonged periods. The same goes for cold garages in winter.
- We recommend that you store your Launcher battery at temperatures between 64°F–82°F (18°C–28°C), away from direct sunlight.

BATTERY CHARGING INSTRUCTIONS

Newer Slinger Bag models offer two ways of charging the battery using the 'smart' cable charger: (1) A quicker 3-step charging option which does not require battery removal and (2) the option to remove the battery. If you prefer removing the battery, please follow the instructions on [page 15](#).



USER NOTE

For additional, and more detailed information about charging and removing your battery pack, visit www.slingerbag.com/support

Before going through the battery charging instructions, please take the following into account:

- Connect the battery to an electrical wall socket using the correct socket adapter provided as part of the charger cable pack.
- Insert the battery charger cable to the charging port on the control panel or if you have removed the battery from the Launcher, insert the battery charger into the back port on the battery box.
- Charging time should be a MAXIMUM OF 5 HOURS in any charging period
- The battery is best fully charged before the first use.
- There is a light on the charger. When the charger is correctly plugged in, the indicator light will turn RED and will change to GREEN when the battery is fully charged. If the indicator light is GREEN please immediately REMOVE the charger from the power outlet to prevent the battery overheating.
- Leaving the battery uncharged for an extended period of time will diminish the battery life.

3-STEP BATTERY CHARGING

This charging method is available to all Slinger Bag models.

Please follow the 3 steps outlined below:

Step 1



Locate the charger connector. You will find it on the bottom right side of your Slinger Bag settings panel.

Step 2



Plug power charger into the charger connector.
Red LED on Power Charger means battery is charging.
Green LED on Power Charger means battery is fully charged.

Step 3



When battery is fully charged (**Green LED** displayed) disconnect the charger cable.



USER NOTE

For additional, and more detailed information about charging or removing your battery pack, visit www.slingerbag.com/support



WARNING

Make sure you switch your Slinger Bag off before charging it.



NOTE

We recommend you remove the battery in case you are not able to monitor your Slinger Bag during the 3-step charging option. Please refer to page 15 for battery removal instructions.

REMOVING YOUR BATTERY PACK

This option is only available for models with serial numbers beginning with the letter 'S'.

Please follow the 7 steps outlined below:

Step 1

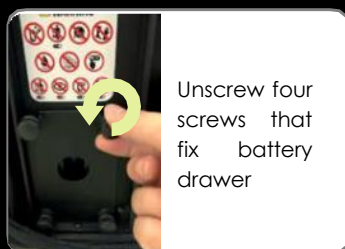

Unscrew four screws that fix battery drawer

Step 2

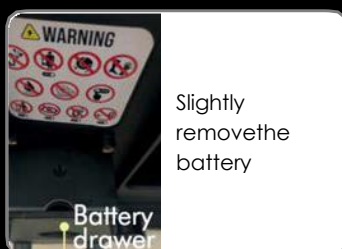

Slightly remove the battery

Step 3



Disconnect the battery wire from the launcher connector.

Step 4

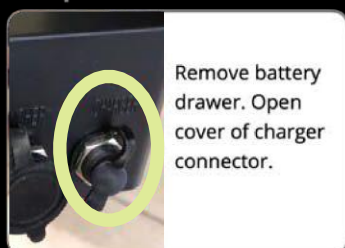

Remove battery drawer. Open cover of charger connector.

Step 5



Plug power charger into the charger connector.

Red LED on Power Charger means battery is charging.

Green LED on Power Charger means battery is fully charged.

Step 6

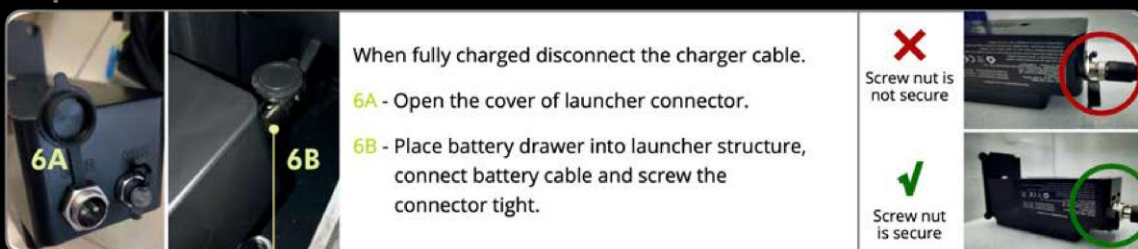

When fully charged disconnect the charger cable.

6A - Open the cover of launcher connector.

6B - Place battery drawer into launcher structure, connect battery cable and screw the connector tight.

✗
Screw nut is not secure

✓
Screw nut is secure

Step 7



Place battery drawer back into the battery housing structure. Screw in the four battery drawer screws and tighten by hand.



USER NOTE

For additional, and more detailed information about charging or removing your battery pack, visit www.slingerbag.com/support



WARNING

Make sure you switch your Slinger Bag off before removing its battery.

BATTERY L.E.D. INDICATORS

The Battery LED lights will illuminate to indicate the level of battery power as follows (looking at the control panel):

- **RED only** indicates LOW power
- **RED & YELLOW** together indicates MEDIUM power.
- **RED, YELLOW, GREEN, GREEN** all together indicates FULL power

OSCILLATOR L.E.D.

The Oscillator LED INDICATOR is GREEN to indicate that the Oscillator is connected and switched on after pressing the Oscillator "ON / OFF" button (lower button) on the remote control.

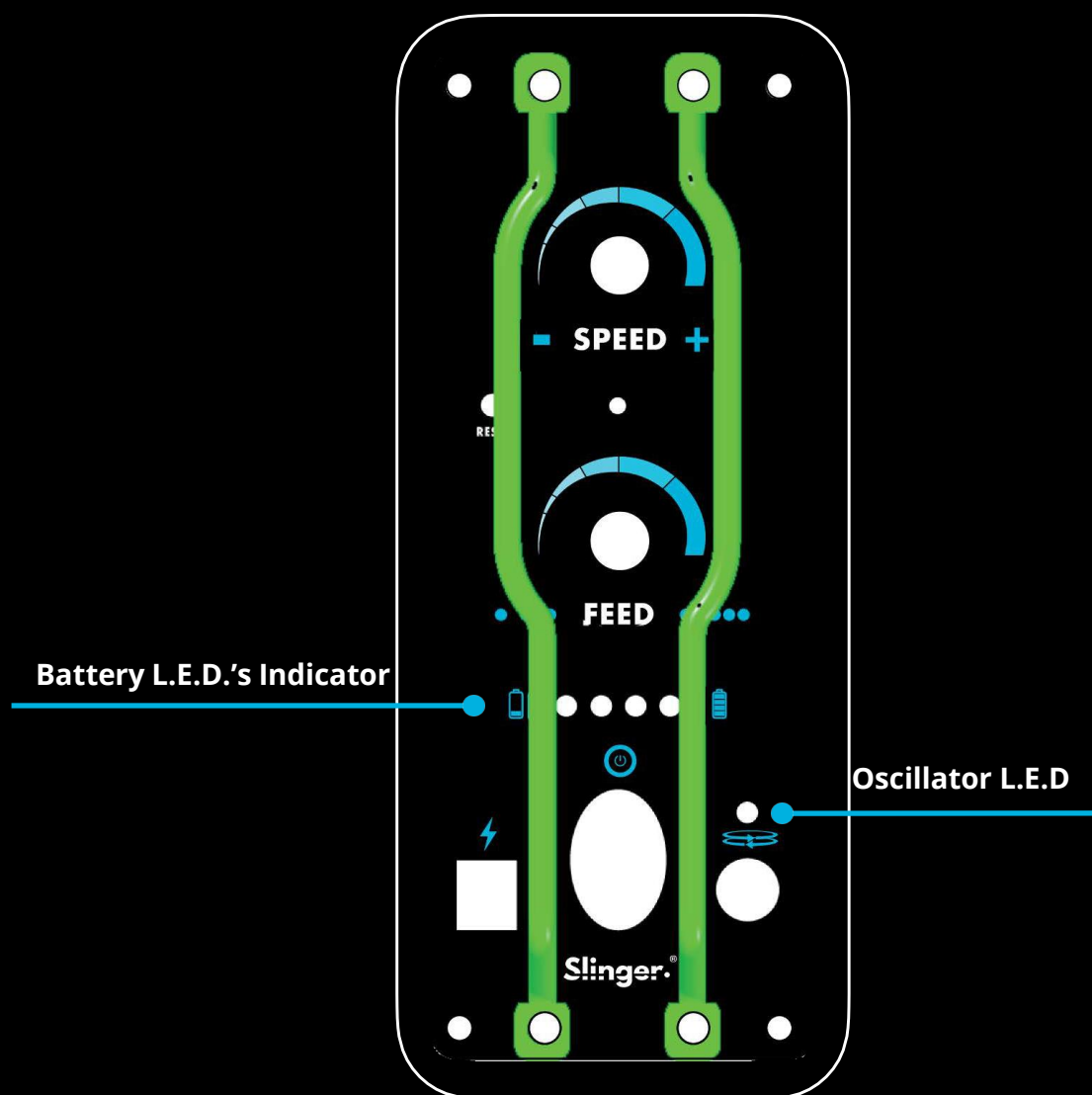

FREQUENTLY ASKED QUESTIONS ABOUT YOUR BATTERY

1. **Can I buy a replacement / spare battery ?**

Yes, replacement batteries can be ordered at SlingerBag.com

2. **My battery has no power ?**

Check battery cable is correctly attached at back of battery (check step 6 on page 7). If the problem persists please contact support@slingerbag.com.

3. **Storage during Winter months**

Store your battery at room temperature to conserve its battery cells.

4. **Can I charge my battery outside of the bag ?**

Yes, in fact we recommend this method of charging and it allows you to store your battery separately from your Slinger Bag, protecting the battery from temperature extremes.

5. **What should I do with my old battery ?**

Slinger products are made from high grade recyclable materials. The battery should be removed from the launcher before it's disposed of and recycled in accordance with local ordinances or regulations. If your battery needs replacing please visit www.slingerbag.com to purchase a replacement.

6. **How long is my Slinger Battery life?**

Lithium-ion batteries are built to last, with energy and power packed into a small area. Over time, all batteries are subject to degradation. So if your run time has declined when the launcher is in regular use, it might be time to buy a new battery.

SLINGER BAG LAUNCHER CONTROLS

1. **POWER:** The power switch turns the Launcher to "ON".

**USER NOTE**

The Remote Control DOES NOT turn the Launcher power on or off. The Remote Control only operates AFTER the Power Switch on the control panel has been switched on.

**WARNING**

Please note that if the ON / OFF switch is switched on then off in rapid succession there is a risk of causing damage to the electronic control panel.

2. **CHARGER:** The battery charger plugs into the charger socket on the front control panel. The recommended charging time for a fully drained battery is a maximum of 5 hours.

**USER NOTE**

Please ensure that the charger plug is fully inserted into the charger socket. There is a "click" felt when the charger plug is correctly inserted into the charger socket.

3. **BATTERY INDICATOR LIGHTS:** The battery is fully charged when all 4 LED lights are showing **RED, YELLOW, GREEN, GREEN**

**USER NOTE**

During use, the Launcher LED lights will blink continuously. The LED lights will go out as power is drained from the battery. Each GREEN or YELLOW light represents about one-third (1/3) of the total battery life. When only the RED LED is showing then the Launcher will soon be out of power.

4. **REMOTE CONTROL RESET:** For resetting or replacing the remote control - see "remote control instructions" [on page 21](#).

5. **GUARD BARS:** These provide protection for the control panel avoiding potential damage if hit by returning balls.

**USER NOTE**

Removing these bars will invalidate the warranty on the T-One Launcher.

6. **BALL SPEED DIAL:** Controls the speed of the balls being fired. The launcher speed ranges from the Ball Boy lowest speed of 10mph/16kmph to an advanced player speed of 45mph / 73kmph with the ball firing with a tournament level of topspin.

SLINGER BAG LAUNCHER CONTROLS (CONTINUED)

7. **LAUNCHER BEEPS (SPEAKER):** A series of “BEEP” sounds can be heard when operating the launcher as follows:
 - a. Short Beep: When switching the Launcher to ‘ON’ on the control panel.
 - b. Short Beep: Whenever pressing the Remote Control “ON” or “OFF”.
 - c. Long Beep: 5 to 10 seconds after pressing the Remote Control launcher button to ‘ON’, indicating that the feeder plate has started to rotate.
 - d. Short Beep: Whenever pressing the Remote Control Launcher button to “OFF”.
 8. **FEED RATE DIAL:** Controls the feed rate of the balls. Feed Rate range is between 2-7 seconds.
 9. **OSCILLATOR* LED:** Indicates when the Oscillator is ‘On’ after pressing the Oscillator remote button.
 10. **OSCILLATOR* CONNECTOR:** Magnetic Plug to connect to the Oscillator cable
- * The oscillator is either sold separately or is included as part of a Slinger product bundle.

ELEVATION KNOB

The elevation knob gives the user an option to change the launching angle of the ball – the launching angle ranges between 10 and 40 degrees.

1. Open the side pocket
2. Rotate the knob counterclockwise to release it
3. Adjust the desired angle
4. Rotate the knob clockwise to lock it



USER NOTE

Please ensure that you LOCK the elevation knob tightly in order to avoid vibration and noise.



CONTROLS

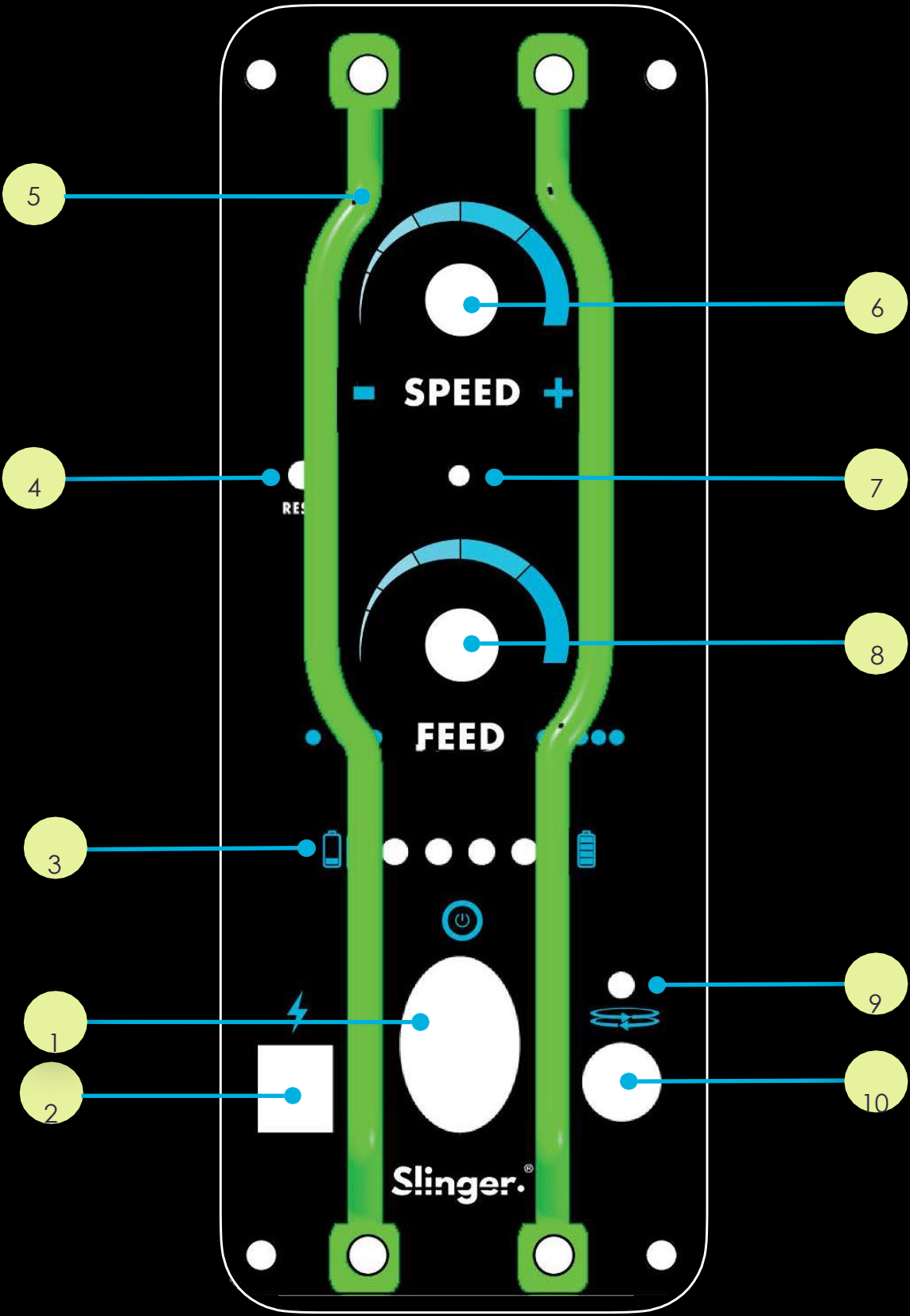

REMOTE CONTROL INSTRUCTIONS



IMPORTANT

The Slinger Bag cannot operate without the remote control for safety reasons. Please make sure that you do not misplace the remote control.



USER SUGGESTION

When not in use attach the remote securely to one of the zipper pulls on the Slinger Bag. It is easy to remove for use and is easily replaced at the end of use.

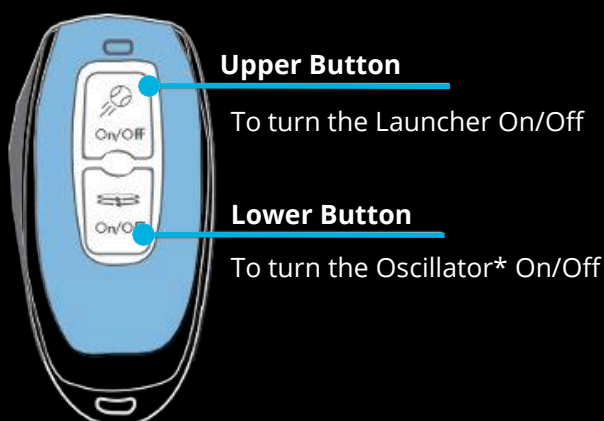

* The oscillator is either sold separately or is included as part of a Slinger product bundle.

HOW TO CHANGE THE REMOTE

In the event the remote control needs to be replaced for any reason please follow these instructions to sync your new remote to your launcher.



USER NOTE

Replacement remote control units can be purchased by visiting:
<https://webshop.dunlopsports.eu/en-gb/replacement-remote-control-r90002>

1. Please ensure that NO BALLS are located inside the bag or the FEEDER PLATE.
2. Switch the launcher to "ON".
3. Using a small pin, push the reset button once (reset button #4 on the control panel).
4. Wait 3-5 sec.
5. Push reset button one more time to complete the syncing.
6. Press the top button on the remote to hear a BEEP which indicates a successful connection.

COURT PLACEMENT

The Slinger Bag court placement depends mainly on the ball speed settings and the launching angle of the ball.

NOTE: Poor quality or condition of the tennis balls used and the outdoor weather conditions will also affect the need to adjust the court placement.

The illustrations below can be used as a reference for locating the Slingshot T-One on the court for ground strokes drills / practice.

A. BALL BOY (Used to practice serving)

Court Placement: Place Slinger Bag near a side line on the same side of the court as the player.

Elevation Angle: Place the elevation bar to the 40 degree elevation mark.

Ball Speed: Set to BEGINNER.

Ball Feed: Set to BEGINNER

B. BEGINNER (Hitting practice)

Court Placement: Place Slinger Bag on the service line on the opposite side of the net to the player

Elevation Angle: Place the elevation bar to 30 degrees

Ball Speed: Set to BEGINNER

Ball Feed: Set to BEGINNER .

C. INTERMEDIATE

Court Placement: Place Slinger Bag near the base line.

Elevation Angle: Place the elevation bar to 20 degrees

Ball Speed: Set to INTERMEDIATE

Ball Feed: Set to INTERMEDIATE

D. ADVANCED

Court Placement: Place Slinger Bag near the baseline.

Elevation Angle: Place the elevation bar to 10 degrees

Ball Speed: Set to ADVANCED

Ball Feed: Set to ADVANCED

COURT PLACEMENT DIAGRAMS

BALL BOY

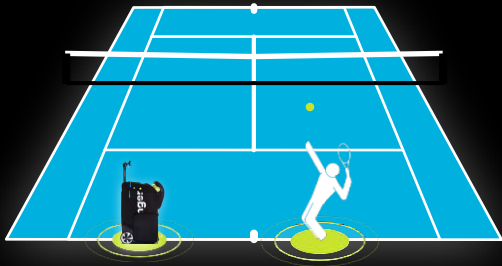

SPEED



FEED



ANGLE

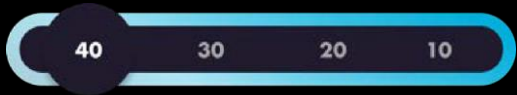

BEGINNER

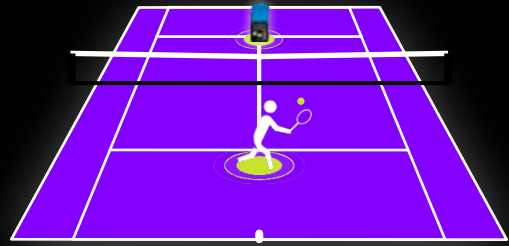

SPEED



FEED



ANGLE



INTERMEDIATE



SPEED



FEED



ANGLE

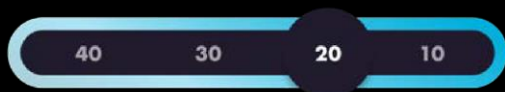

ADVANCED

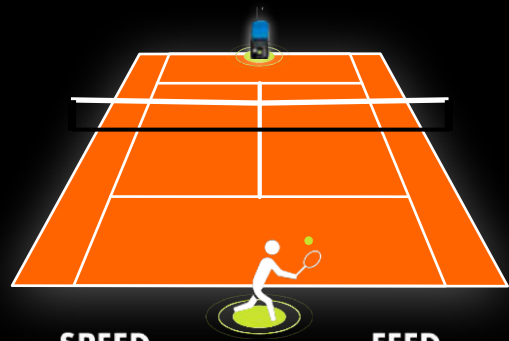

SPEED



FEED



ANGLE

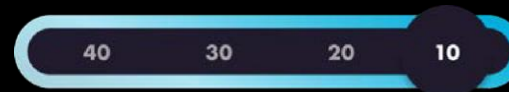

TROUBLESHOOTING & MAINTENANCE

After use, ball fuzz or court dust can typically build up on the fascia of the launcher. This is best removed using readily available pressurized air canisters, or by using a damp cloth.

- For General cleaning, when possible please use a pressurized air canister to clear.
- Use a damp cloth to wipe down the exterior surfaces of the machine.
- Never scrape at the surface of your Launcher with a sharp object, or use any harsh abrasives or solvents.
- Loose debris can be vacuumed out of the Launcher.
- Never use a water hose to attempt to remove debris out of the interior of the machine. Water pressure will damage the sensitive electrical components, as well as increase the risk of electric shock.

STORAGE

The following actions will ensure optimum performance:

- When the Launcher is not in use, it should be stored in a dry and clean area.
- Excessive exposure to wind, rain, sunlight, etc. can often interfere with the operation of the sensitive electrical components and cause fading and/or other damage to Slinger Bag exterior.
- Do not store the battery for more than 30 days without recharging it to a minimum 30% level.
- We recommend that the Slinger is stored at temperatures between 64°F–82°F (18°C–28°C), away from direct sunlight.

FACTORY TESTING

Before shipping, every Slinger Bag is fully QC tested at several points across the production assembly. As a result, there may be some residual ball fuzz either inside or on the front of your Slinger Bag Launcher and/or possibly other marks left as a result of this QC testing. This is perfectly normal.

TROUBLESHOOTING



USER NOTE

For more information visit: www.slingerbagg.com/support.



WARNING

Please make sure that the launcher power is in 'OFF' position before investigating any issues. For additional or specific help please email support@slingerbagg.com.

PROBLEM	CAUSE	ACTION REQUIRED
Ball is not launched	A ball is jammed in either the Feeder Plate or the Ball Chute.	TURN OFF POWER, WAIT 1 MINUTE FOR THE FIRING WHEEL TO STOP ROTATING and only then remove any jammed balls from either the feeder plate or from the Ball Launcher chute.
Ball is not launched	Tennis balls and/or pitching wheels are wet.	Wheels and/or balls require cleaning and drying. Remove any wet balls from hopper.
Feeding plate does not turn	A ball is jammed / too many balls in the hopper.	TURN OFF POWER and remove any jammed balls / from the hopper.
Feeding plate does not turn	Remote "On" not activated No battery power.	Standing to the front and side of the Launcher, press top button on remote once to start feeder plate rotation.

PROBLEM	CAUSE	ACTION REQUIRED
Feeding plate does not turn	If above fails to activate the feeder.	Return for warranty.
Loud noise and / or vibration	Loose elevation bar knob.	Tighten the elevation knob.
Battery Not Charging and has no light when connected to a power outlet	Charger cable is not fully inserted in control panel.	Check all connections. Check power socket adapter is correctly selected and connected.
Oscillator not operating	Magnetic Cable attachment needs cleaning.	Ensure that both ends of the magnetic connector are free from debris, dust etc.
Oscillator not operating	Remote control button not activated.	With the Launcher "ON" press lower button on remote control to activate launcher. When Oscillator is connected there is a green LED illuminated above the magnetic connector socket.
Oscillator not operating	If the above have been checked and still no operation.	Return for warranty.
Ball Tube issues: Ball stuck inside Blue end cap damaged	Known issue.	<p><u>For North America Markets</u> Please email support@slingerbag.com</p> <p><u>For all other markets</u> Please contact your local distributor. Please see distributor information at www.slingerbag.com/distributors</p>

LIMITED WARRANTY

See our Warranty Policy at slingerbag.com/warranty

Your Slinger Bag comes with a standard Limited 1 year warranty (Limited 2 Year Warranty as standard in EU member markets) covering any manufacturing defects.



USER NOTE

Please note that the warranty is not offered in all International markets. Please check with your local Slinger Distributor for full warranty information.

The serial number can be found here:



WHO IS COVERED?

- The original owner of the Slinger Launcher, Oscillator, Collector Tube and Cell Phone Holder. The Slinger Launcher, Oscillator, Collector Tube and Cell Phone Holder must remain in the possession of the original purchaser for the warranty to remain valid. This Limited Warranty is not transferable.

WHAT IS COVERED?

- If a defect arises in the Slinger Launcher, Oscillator, Collector Tube, Cell Phone Holder or any warranted component within the applicable Limited Warranty period, the purchaser's sole and exclusive remedy is for Slinger Bag to, at Slinger Bag's discretion to the extent permitted by law, either replace or repair the defective or malfunctioning Slinger Launcher, Oscillator, Collector Tube, Cell Phone Holder or component with the same or a comparable model.
- Any replacement or repaired component shall be warranted for the remainder of the original Limited Warranty period or 30 days, whichever is longer, or for any additional period that is required by applicable law.

LIMITED WARRANTY

See our Warranty Policy at slingerbag.com/warranty

WHAT IS **NOT** COVERED?

- Tennis Balls of any kind.
- Lithium-Ion Battery charge capacity or battery life
- Normal wear and tear
- Cosmetic damage (i.e., minor scratches, surface deformations or discoloration) including natural fading of colors
- Damage caused by exposure to inclement weather
- Damage caused by rips, cuts and tears
- Products treated with steaming devices or other heat treatments
- Products with removed or defaced holograms or date codes
- Products purchased from unauthorized dealers (including, without limitation, products purchased through (i) auction sites such as E-Bay or Craigslist, (ii) unauthorized dealers selling via third party marketplaces such as Amazon marketplace, or (iii) dealers selling altered, doctored or counterfeit products)
- Counterfeit products
- Products purchased "used", "as-is", "without warranty";
- Any other Slinger Bag products or services, non-Slinger Bag products, units that are, or that Slinger Bag reasonably believes to be, stolen, counterfeit, or purchased from an unauthorized distributor or reseller, units purchased outside of the user's main market and units missing their serial number.
- Damage or equipment failure due to normal wear and tear, improper or negligent use, maintenance, or attempted repair (other than that caused by a Slinger Bag authorized service technician), use of the Slinger Launcher, Oscillator, Collector Tube or Cell Phone with parts or accessories from third parties, or with parts or accessories not originally intended for or compatible with the Slinger Launcher, Oscillator, Collector Tube or Cell Phone or any use contrary to the instructions in the Slinger Bag User Guide.
- Damage or equipment failure due to accident, abuse, improper or abnormal use, neglect, corrosion, discoloration of paint or plastic (or any other change in cosmetic appearance that does not affect performance), theft, vandalism, fire, flood, wind, lightning, freezing or other natural disasters or acts of God of any kind, electrical wiring, power reduction, power fluctuation or power failure from whatever cause, unusual atmospheric conditions, collision, the introduction of foreign objects, or modifications that are unauthorized or not recommended by Slinger Bag.

LIMITED WARRANTY

See our Warranty Policy at slingerbag.com/warranty

WHAT IS NOT COVERED? (CONTINUED)

- Incidental or consequential damages. Slinger Bag is not responsible or liable for indirect, special, incidental or consequential damages, economic loss, loss of property or profits, loss of enjoyment or use, or other consequential damages of any nature whatsoever in connection with the purchase, use, repair or maintenance of equipment or parts. Slinger Bag does not provide monetary or other compensation for any such repairs or replacement parts costs, including but not limited to club membership fees, work time lost, cost of substitute equipment, diagnostic visits, maintenance visits or transportation.
- Any attempt to repair Slinger Bag equipment creates a risk of injury and property damage. Slinger Bag is not responsible or liable for any damage or injury incurred during, or as a result of, any repair or attempted repair of equipment by anyone other than a Slinger Bag authorized service technician. All repairs attempted by you or your agents are undertaken AT YOUR OWN RISK and Slinger Bag will have no liability for any injury to persons or property arising from such attempted moves or repairs.
- Where permitted by law, replacement units, parts and electronic components reconditioned to as-new condition by Slinger Bag or its vendors may sometimes be supplied as warranty replacement and constitute fulfillment of warranty terms.

THIS LIMITED WARRANTY IS THE EXCLUSIVE WARRANTY GIVEN BY SLINGER BAG AND SUPERSEDES ANY PRIOR, CONTRARY OR ADDITIONAL REPRESENTATIONS. ALL OTHER WARRANTIES, EXPRESS OR IMPLIED, INCLUDING ANY STATUTORY WARRANTY OR CONDITION OF MERCHANTABILITY OR FITNESS FOR A PARTICULAR PURPOSE, ARE DISCLAIMED TO THE MAXIMUM EXTENT PERMITTED BY LAW. IN SUCH EVENT, SUCH WARRANTY IS LIMITED TO THE DURATION OF THE WARRANTY PERIODS SET FORTH ABOVE. THIS EXCLUSION APPLIES EVEN IF THIS WARRANTY FAILS OF ITS ESSENTIAL PURPOSES AND REGARDLESS OF WHETHER DAMAGES ARE SOUGHT FOR BREACH OF WARRANTY, BREACH OF CONTRACT, NEGLIGENCE, OR STRICT LIABILITY IN TORT OR UNDER ANY OTHER LEGAL THEORY. SOME JURISDICTIONS DO NOT ALLOW THE EXCLUSION OR LIMITATION OF INCIDENTAL OR CONSEQUENTIAL DAMAGES, SO THE ABOVE LIMITATION MAY NOT APPLY TO YOU. THIS LIMITED WARRANTY GIVES YOU SPECIFIC LEGAL RIGHTS, AND YOU MAY ALSO HAVE OTHER LEGAL RIGHTS, WHICH VARY FROM STATE TO STATE.

Please ensure that the power is switched to “OFF” and unplugged from any electrical connection before attempting any activity which involves reaching into the launcher mechanism for any reason including for maintenance or cleaning.



IMPORTANT

The Slinger Bag cannot operate without the remote control for safety reasons. Please make sure that you do not misplace the remote control.

GLOBAL COMPLIANCE & CERTIFICATION

Battery type	Certification item	Applicable area	Testing standard	Issue Unit	Period of validity	Mandatory	Certified
14.4v 6.6ch	CB	EU/International	IEC62133-2 : 2017	UL	long-term effective unless the standard is change	Yes	Yes
	CE-EMC	EU	EN55032/EN55024 or EN61000-6-1/3	UTL	long-term effective unless the standard is change	Yes	Yes
	UN38.3	International transport	UN(T1-T8) Revised Edition 6	UTL+Air report (DGM)	long-term effective unless the standard is change	No	Yes
	MSDS		New edition OSHA	UTL	validity for one year	No	
	BIS	India	IS16046	BIS	It is valid for two years and can be renewed before the certificate expires.	Yes	Yes
	BSMI	Tiawan	CNS15364	BSMI	It is valid for three years and can be renewed before the certificate expires.	Yes	Yes
	RCM	Australia & New Zealand	AS/NZS CISPR 22	UTL	long-term effective unless the standard is change	Yes	Yes
	PSE	Japan	Appendix 9	UTL	long-term effective unless the standard is change	Yes	Yes
	KC	Korea	KC62133	KTC	long-term effective unless the standard is change	Yes	Yes
	UL	USA	UL2054	UL	need audit factory four times a year, long-term effective unless the standard is change	No	No
UL	Canada	UL2054+UL62368	UL	need audit factory four times a year, long-term effective unless the standard is change	No	No	

Category	Product	Certification	Certification Standards
Launcher	6.6Ah Battery	CB	<ul style="list-style-type: none"> • IEC 62133-2:2017 • EN 62133-2:2017
		CE EMC	<ul style="list-style-type: none"> • EN 61000-6-3:2007+A1:2011+AC:2012 • EN IEC 61000-6-1:2019 • EN IEC 61000-3-2:2019 • EN61000-3-3:2013+A1:2019
	2A Power Charger	CB	<ul style="list-style-type: none"> • IEC 61558-1:2005+A1 • IEC 61558-2-16:2009+A1
		CE-EMC & CE-LVD	<ul style="list-style-type: none"> • EN 55014-1:2007 • EN 55014-2:2015 • EN IEC 61000-3-2:2019 • EN 61000-3-3:2013 • EN 61558-1:2005+A1 • EN 61558-2-16:2009+A1
		RoHS	European Council Directive 2011/65/EU on the Restriction of the Use of Certain Hazardous Substances in Electrical and Electronic Equipment
		GS	<ul style="list-style-type: none"> • EN 61558-1:2005+A1 • EN 61558-2-16:2009+A1
	6300RPM Big Motor	CE	<ul style="list-style-type: none"> • EN 55014-1:2006/A2:2011 • EN 55014-2:1997/A2:2008
		RoHS	2011/65/EU Restriction of Hazardous Substances
	Launcher Gear Motor	CE-EMC	<ul style="list-style-type: none"> • EN 61000-6-3:2007+A1:2011 • EN IEC 61000-6-1:2019
		RoHS	<ul style="list-style-type: none"> • IEC 62321-3-1:2013 • IEC 62351-5:2013 • IEC 62321-4:2013+AMD1:2017 • IEC 62321-7-1:2015 • IEC 62321-7-2:2017 • IEC 62321-6:2015 • IEC 62321-8:2017





Europe



RoHS COMPLIANT

REACH



Category	Product	Certification	Certification Standards
Launcher	PCB	RoHS (for LF HASL)	<ul style="list-style-type: none"> • RoHS Directive (EU) 2015/863 amending Annex II to Directive 2011/65/EU • IEC 62321-4:2013+A1:2017 • IEC 62321-5:2013
		REACH (for SVHC)	<ul style="list-style-type: none"> • IEC 62321-72:2017 • IEC 62321-6:2015 • IEC 62321-8:2017 • Analyzed ICP-OES, UV-Vis, and GC-MS
	433MHz Remote	CE Red	<ul style="list-style-type: none"> • Radio Equipment Directive (RED) 2014/53/EU • EN 62479:2010 • EN 50663:2017 • Final draft EN 301 489-1 V2.2(2019-09) • En 301 489-3 V2.1.1(2019-03) • EN 300 220-1 V3.1.1(2017-02) • EN 300 220-2 V3.1.1(2017-02)
Oscillator	Oscillator Gear Motor	CE-EMC	<ul style="list-style-type: none"> • EN 61000-6-3:2017+A1:2011 • EN 61000-6-1:2019
		RoHS	<ul style="list-style-type: none"> • IEC 62321-3-1:2013 • IEC 62351-5:2013 • IEC 62321-4:2013+AMD1:2017 • IEC 6232-7-1:2015 • IEC 62321-7-2:2017 • IEC 62321-6:2015 • IEC 62321-8:2017
Ball Tube		CE	<ul style="list-style-type: none"> • EN 71-1:2014+A1:2018 • EN 71-2:2011+A1:2014 • EN 71-3:2013+A3:2018



Americas



IC

California 65

ASTM

Category	Product	Certification	Certification Standards
Launcher	2A Charger	FCC	<ul style="list-style-type: none"> • FCC Part 15 Subpart B, 10-1-2014 Edition
		UL/CUL	<ul style="list-style-type: none"> • UL 60950-1, 2nd Edition, 2014-10-14 (Information Technology Equipment - Safety- Part 1: General Requirements) • CAN/ CSA C22.2 No. 60950-1-07, 2nd Edition, 2014-10 (Information Technology Equipment - Safety- Part 1: General Requirements)
		Argentina Safety-Mark License	<ul style="list-style-type: none"> • IEC 61558-1:2005+A1 • IEC 61558-2-16:2009+A1 • IRAM 2063:2009
	PCB	UL (for Wiring, Printed-Component)	
	433 MHz Remote Control	FCC	<ul style="list-style-type: none"> • FCC Part 15, Subpart C, Section 15.231 • ASNI C63.10-2013
		IC	<ul style="list-style-type: none"> • RSS-210 Issue 9 Aug, 2016
	Trolley Bag	California 65 (for Fabric & Printing)	
		Consumer Safety	



Category	Product	Certification	Certification Standards
Launcher	6.6Ah Battery	KC	• KC62133-2 (2020-07)
		PSE	• Interpretation for METI Ordinance of Technical Requirements (H25.07.01) Appendix 9: Lithium ion secondary batteries
		BSMI	• CNS15364
		BIS	• IS 16046 (Part 2):2018/ IEC 62133-2:2017
		RCM	• EN 61000-6-3:2007+A1:2011+AC:2012; EN IEC 61000-6-1:2019 ; EN IEC 61000-3-2:2019EN 61000-3-3:2013+A1:2019; IEC 62133-2:2017
	2A Charger	SAA	• AS/ NZS 61558.1:2008+A1+A2+A3 • AS/ NZS 61558.2:16:2010+A1+A2+A3
		CCC	• CNCA-C09-01:2014 • GB4943.1-2011 • GB/T9254-2008 • GB17625.1-2012
		PSE	• Interpretation on Ministerial Ordinance establishing Technical Requirements Appendix 12: j61558-1(H26), j61558-2-16(h26), j55014-1(h20) • Appendix 4 of the Enforcement Regulations (AC Electrical Appliances)
		KC & KCC	• K 60950-1 (2011-12) • Clause 3, Article 58-2 of Radio Waves Act.
	433 MHz Remote Control	KC RF	• K 60950-1 (2011-12) • Clause 3, Article 58-2 of Radio Waves Act.
315 MHz Remote Control	MIC	• Technical Regulations Conformity Certification of Special Radio equipment(ordinance of MPT N° 37, 1981) • ARIB STD-T93 V1.1 (2007-09)	

Category	Product	Certification	Certification Standards
Launcher	6.6Ah Battery	UN38.3	• ST/SG/AC.10/Rev.6/Amend.1/Section 38.3
		Material Safety Data Sheet (MSDS)	• EEC Directive 93/112/EC • UN Recommendation on the Transport of Dangerous Goods
		Identification and Classification Report for Air Transport of Goods	• IATA Dangerous Goods Regulations • IATA DGR 61st, 2020 • IATA DGR 62nd, 2021
		Identification and Classification Report for Transport of Goods (By Sea)	• IMDG CODE (Amdt 39-18)
		Lithium Cells for Battery Test Summary	• UN Manual of Tests and Criteria Part III Subsection 38.3, Rev.6/Amend.1

This product complies with applicable requirements for performance, construction, labelling and information.

EUROPEAN COMPLIANCE

As indicated by this symbol, disposal of this product is governed by Directive 2012/19/EU of the European Parliament and of the Council on waste electrical and electronic equipment (WEEE). WEEE could potentially prove harmful to the environment and as such the Directive requires that the battery in this product must not be disposed of as unsorted municipal waste, but rather collected separately and disposed of in accordance with local WEEE ordinances and guidelines.

ENERGY CONSUMPTION

In accordance with Directive 2009/125/EC this device is equipped with a power switch.

The following energy consumption figures apply (measured with a watt meter at the outlet):

Switch in OFF position = 0.0 watts

Switch in ON position = 120 watts